

MEM Deck-mounted basin spout with pop-up waste - Brushed Durabronz (23kt Gold)









MEM

13 715 782



- 200mm projection
- fixed spout
- rectangular, air-enriched flow
- height of mixer 321 mm
- height up to aerator 190 mm
- hole diameter 35 mm
- 2x screw-in M 10 x 1 pressure hose, leak-tested
- rosette 60 x 60 mm
- max. flow 5.7 l/min
- lead-free
- This product can help a building meet the requirements of Green Building Rating Systems, e.g. LEED®, BREEAM®, DGNB

Only suitable for basins with an overflow.

| | | |
|---|-------------------------------|---------------|
|  | Brushed Durabronz (23kt Gold) | 13 715 782-28 |
|  | Chrome | 13 715 782-00 |
|  | Brushed Platinum | 13 715 782-06 |
|  | Platinum | 13 715 782-08 |
|  | Dark Chrome | 13 715 782-19 |
|  | Brushed Champagne (22kt Gold) | 13 715 782-46 |
|  | Champagne (22kt Gold) | 13 715 782-47 |
|  | Brushed Dark Platinum | 13 715 782-99 |

13 715 782
mm [inches]

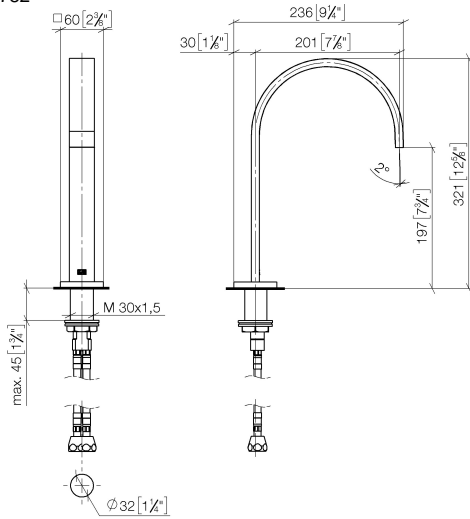

Flow rate chart



Certificates

GDV_0400289.

13 715 782
Parts for other finishes can be found here: [Chrome](#)

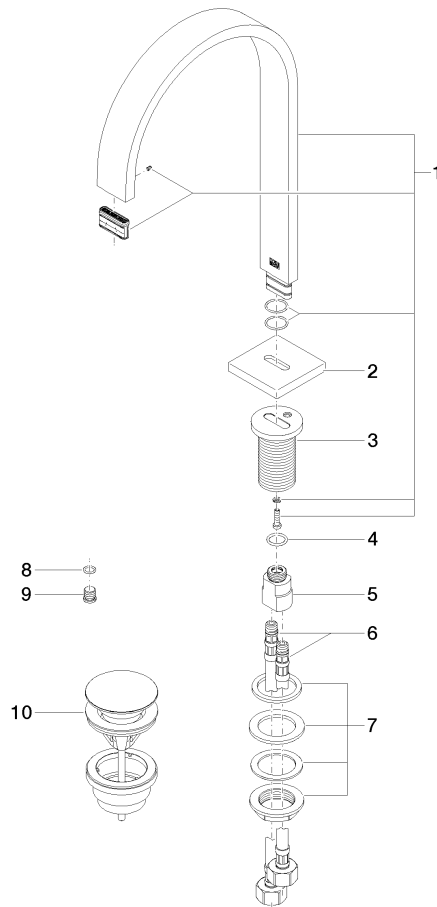

Spare parts list

| No. | Item Number | Name | Quantity used | Delivery time |
|-----|--------------------|--|---------------|---------------|
| 1 | 90 28 22 155 01-28 | spout | 1 | 20 |
| 2 | 09 27 78 034-28 | rosette | 1 | 20 |
| 3 | 09 11 10 054 10 90 | connection | 1 | 2 |
| 4 | 09 14 10 130 90 | seal | 1 | 2 |
| 5 | 09 11 10 055 10 90 | connection | 1 | 2 |
| 6 | 04 30 04 019 00 90 | hose | 2 | 2 |
| 7 | 04 23 10 009 01 90 | fixing set | 1 | 2 |
| 8 | 90 14 10 060 00 90 | seal | 1 | 2 |
| 9 | 09 31 20 065 90 | plug | 1 | 2 |
| 10 | 10 125 970-28 | Basin Waste with push fastening 1 1/4" - Brushed Durabronz (23kt Gold) | 1 | 2 |